

Products /  **CASTALDI** / TAU D43 / D43 TAU/2 / D43/2-LWN-GR

TAU D43 D43/2-LWN-GR

TECHNICAL DATA

GENERAL



Item code	D43/2-LWN-GR
Place installation	outdoor
Name	D43 TAU/2 / D43/2-LWN-GR pole mounted, low pole/bollard
Note	DALI version on request.
Standard colour	GR - graphite satin finish (similar to RAL 7022)
Environments	urban landscape, façades and architectural works, hallway



PHYSICAL

Installation type	pole mounted, low pole/bollard
Mounting type	pole, ground surface
Painting	Polyester powder coating, with a pluri-processed against corrosion (passed the exposure of over 1500 hours in a saline mist environment).
Screws	AISI 304 stainless steel screws.
Seals	Silicone Rubber.
Body	Corrosion resistant die-cast aluminium body.

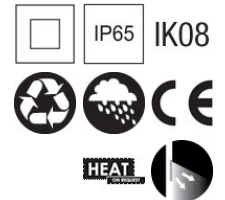

DIMENSIONS

H: Total height device (mm)	65
D: Total diameter device (mm)	370

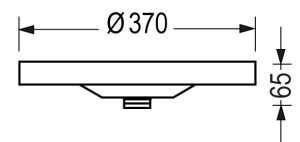

OPTICAL SYSTEMS

Opening beam	roto-symmetrical
Optical System	Aluminum reflector.
Reflectors	Extra-pure aluminium reflector.
Diffuser	Unbreakable UV-resistant polycarbonate.

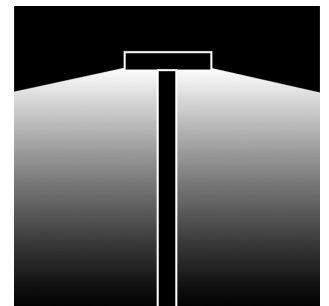

ENERGY SAVING

This luminaire contains built-in LED lamps
The lamps cannot be changed in the luminaire

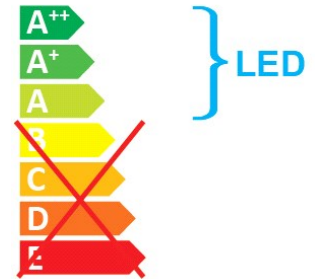

SOURCES

Source Type	Source Power	System Power	Source	Lamp Socket	Sources Temperature Colour	Nominal Flux	Output Flux	Source description
LED	-	29W	-	-	4000K CRI>80	-	1470 lm	-

ELECTRICAL

Ballast type	Electronic
Mounting ballast type	Integral
Line input	Complete with pre-wired and tested watertight H07RN-F cable.
Voltage	220-240V
Frequency	50-60Hz

PHOTOMETRICS

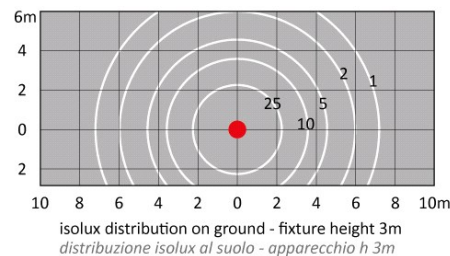
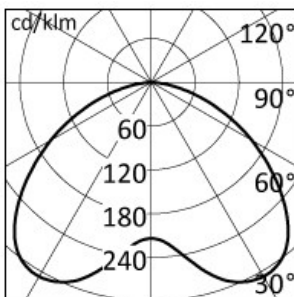

NORMS / DIRECTIVES

Norms	EN 60598-1, EN 60598-2-5
Directives	2014/35/UE, 2014/30/UE

ACCESSORIES

OPTIONAL ACCESSORIES

Mounting

Accessory code	D43/BS
Technical description	For models D43 tau/1/2. Independent fixing base for low poles.
H: Total height device (mm)	204
Body	Aluminium.

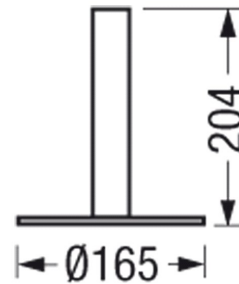
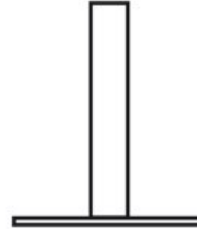

Accessory code	D43/P
Technical description	For models D43 tau/1/2. Ground recessed pit with fixing base. The D43/P accessory, ground recessed pit for electrical connection housing complete with fixing base D43/BS.
H: Total height device (mm)	110

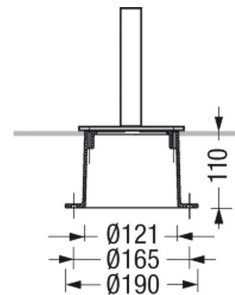
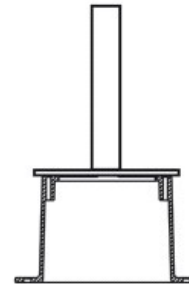

Pole

Accessory code	D43/PT135-GR
Technical description	For models D43 tau/1/2. Ø40mm aluminium poles. Height: 1350mm.
H: Total height device (mm)	1350

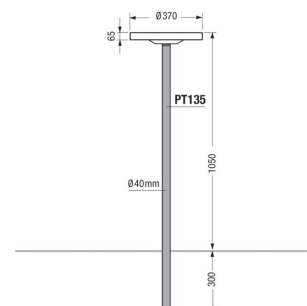

Accessory code D43/PT65-GR

Technical description
For models D43 tau/1/2. Ø40mm aluminium poles. Height: 650mm.

H: Total height device (mm) 650

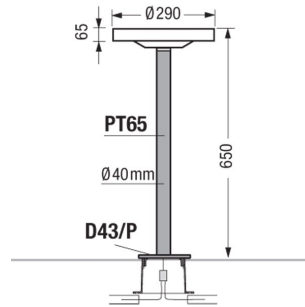

Accessory code D43/PT85-GR

Technical description
For models D43 tau/1/2. Ø40mm aluminium poles. Height: 850mm.

H: Total height device (mm) 850

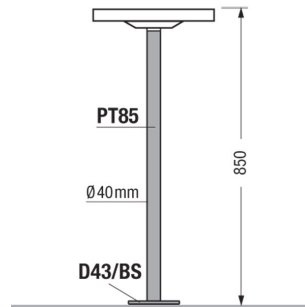

Accessory code D43/P1-GR

Technical description
Pole top fixing for Ø60x100mm -GR GRAPHITE, for tau/1 and tau/2.



Accessory code D43/P300-GR

Technical description
Extruded anodized aluminum pole Ø60mm, height above ground level 3m - GR GRAPHITE.

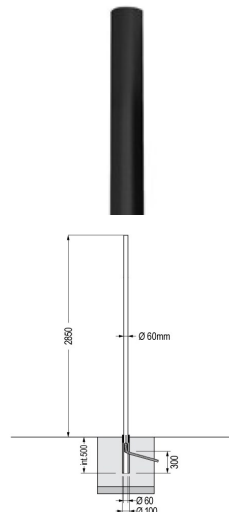

Accessory code

D43/R60-GR

Technical description

Pole top fixing for Ø60mm -GR GRAPHITE,
for tau/1 and tau/2 (to be combined with
code D43/P300).

